

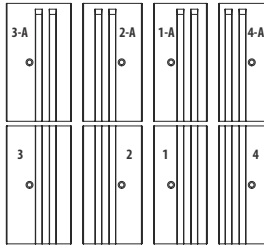

GRAPHIX

DESCRIPTION: Wall double-sided **TEXTURE:** Smooth & Split face

PALLET OVERVIEW



COMPATIBLE CAPS

See page 103 for product compatibility.

NOTES

See page 99 to 119 for more technical information.

01 | Linear pattern

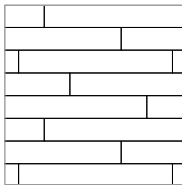









Patterns are for design inspiration only. The installer is responsible to calculate & purchase the correct amount of material.

Visit our website for more patterns.



| Specifications per pallet | Imperial | Metric |
|---------------------------|-----------------------------|---------------------|
| Cubing | 26.25 ft² | 2.44 m ² |
| | 107.67 lin. ft | 32.51 m lin. |
| Approx. Weight | 2 773 lbs | 1 258 kg |
| Number of rows | 8 | |
| Coverage per row | 3.28 ft ² | 0.30 m ² |
| Linear coverage per row | 13.33 lin. ft | 4.06 lin. m |

| | Unit dimensions | in | mm | Units/pallet |
|---|---------------------------|--|------------------|--|
|  1 | Height Depth Length | 2 ¹⁵ / ₁₆ 9 ¹ / ₁₆ 20 | 75 230 508 | 8 units |
|  2 | Height Depth Length | 2 ¹⁵ / ₁₆ 10 ¹ / ₁₆ 20 | 75 255 508 | 8 units |
|  3 | Height Depth Length | 2 ¹⁵ / ₁₆ 11 20 | 75 280 508 | 8 units |
|  4 | Height Depth Length | 2 ¹⁵ / ₁₆ 8 ¹ / ₁₆ 20 | 75 205 508 | 8 units split on one side |
|  1A | Height Depth Length | 2 ¹⁵ / ₁₆ 9 ¹ / ₁₆ 20 | 75 230 508 | 8 units Left corner unit |
|  2A | Height Depth Length | 2 ¹⁵ / ₁₆ 10 ¹ / ₁₆ 20 | 75 255 508 | 8 units Right corner unit |
|  3A | Height Depth Length | 2 ¹⁵ / ₁₆ 11 20 | 75 280 508 | 8 units Left corner unit |
|  4A | Height Depth Length | 2 ¹⁵ / ₁₆ 8 ¹ / ₁₆ 20 | 75 205 508 | 8 units Right corner unit, split on one side |

CLEAN SAND/GRAVEL/ SAND AND GRAVEL MIXES ($\phi=34^\circ$, $\gamma = 120$ pcf)
GEOGRID: MIRAGRID 2XT BY TENCATE (RFd=1.10, RFcr=1.45, RFid=1.25, Cds=0.9, Ci=0.9)

CASE N° 1 :
No Surcharge
No Backslope
No Toe Slope

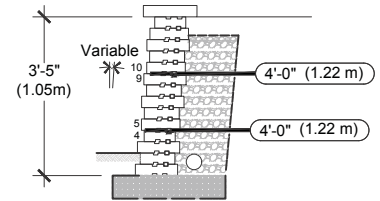
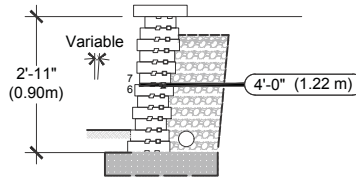
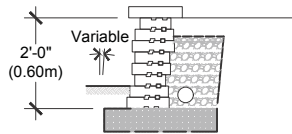

VISIT WWW.TECHO-BLOC.COM FOR COMPLETE DESIGN CHART DOCUMENT

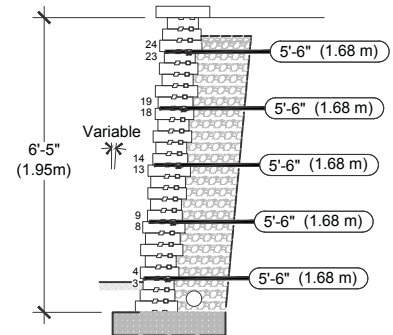
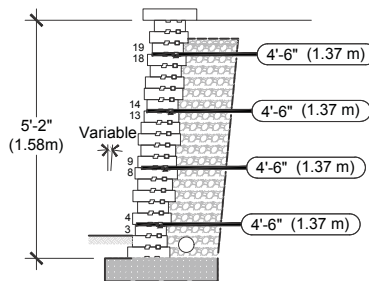
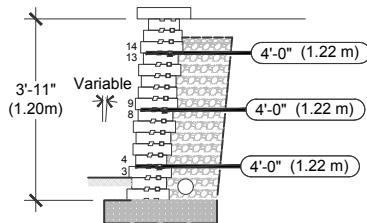

1. The information contained in the design charts is supplied for information purposes only and as such should only be used for preliminary designs.
2. The height (H) of the wall is the total height from the leveling pad to the top of the wall not including the thickness of the cap.
3. Soil parameters: reinforced soil ($\phi = 34^\circ$, $\gamma = 120$ pcf); retained soil ($\phi = 34^\circ$, $\gamma = 120$ pcf); foundation soil ($\phi = 34^\circ$, $\gamma = 120$ pcf)
4. A qualified engineer should be consulted for the final design to be used for construction.
5. The foundation soil must be able to support the wall system. The bearing capacity of the foundation soil, settlement, and global stability must be verified and validated by a qualified geotechnical engineer.
6. The seismic analysis is not included.
7. The design charts do not apply to tiered walls.
8. The charts assume that the walls are constructed in accordance with Techo-Bloc specifications, good construction practice and an adequate drainage system.
9. The geogrid layout has been optimized to satisfy the design requirements of the NCMA's Design Manual for Segmental Retaining Walls, 3rd Edition.
10. The minimum burial depth must be 6 in (150 mm) or 10% of the exposed height, whichever is greater.
11. Engineering judgement should be used when interpolating between heights.
12. Techo-Bloc and its predecessors, successors, beneficiaries, employees, associates, administrators and insurers accepts no liability for the incorrect use of information contained in the design charts.
13. For further information, please contact our technical service department.

INSTALLATION GUIDE

FREESTANDING WALLS - GRAPHIX

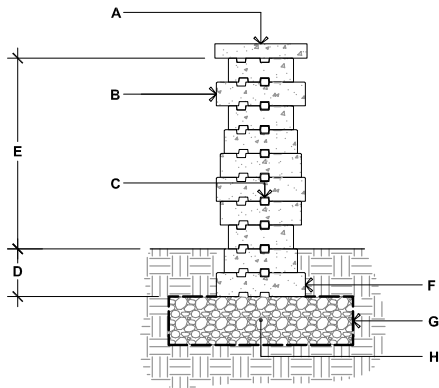

GRAPHIX

- A. TECO-BLOC CAP UNIT SECURED TO UNIT BELOW WITH CONCRETE ADHESIVE
- B. GRAPHIX DOUBLE-SIDED WALL UNITS SECURE EACH ROW WITH CONCRETE ADHESIVE
- C. CONNECTOR
- D. EMBEDMENT DEPTH, 6" (150 mm) MIN.
- E. 23 1/2" (600 mm) MAX.
- F. FOR THE FIRST ROW, ALWAYS USE THE DEEPER GRAPHIX BLOCK
- G. GEOTEXTILE
- H. COMPACTED GRANULAR LEVELING PAD, 6" (150 mm) THICK MIN. THICKNESS ACCORDING TO PROJECT SPECIFIC CONDITIONS

90° CORNER OF A DOUBLE-SIDED WALL

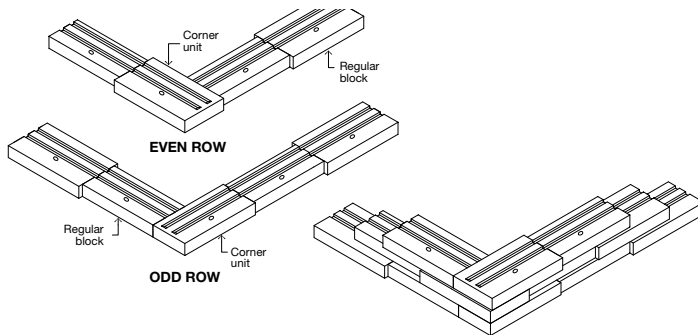

1. Alternate odd and even rows.
2. Stagger joints from one row to the next.
3. Glue all modules at each row with a concrete adhesive.
4. Connectors are not illustrated to avoid overloading the image.
5. It is possible to alternate the blocks (1, 2, 3 or 4) in the same row to create different patterns. However, a corner block (1A, 2A, 3A or 4A) must always be present at the end of a row and must be alternated for each subsequent row.
6. At the corner, make sure to place the blocks so that the grooves of the block cannot be seen.

DOUBLE-SIDED WALL - END OF A STRAIGHT WALL

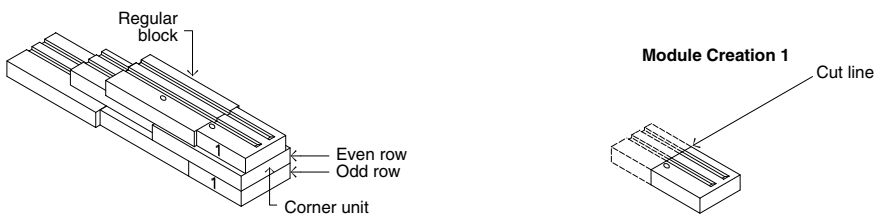

* It is possible to alternate the blocks (1, 2, 3 or 4) in the same row to create different patterns. However, a corner block and a cut corner block (1A, 2A, 3A or 4A) must always be present at the end of a row and must be alternated for each subsequent row.

INSTALLATION GUIDE

PILLARS - GRAPHIX

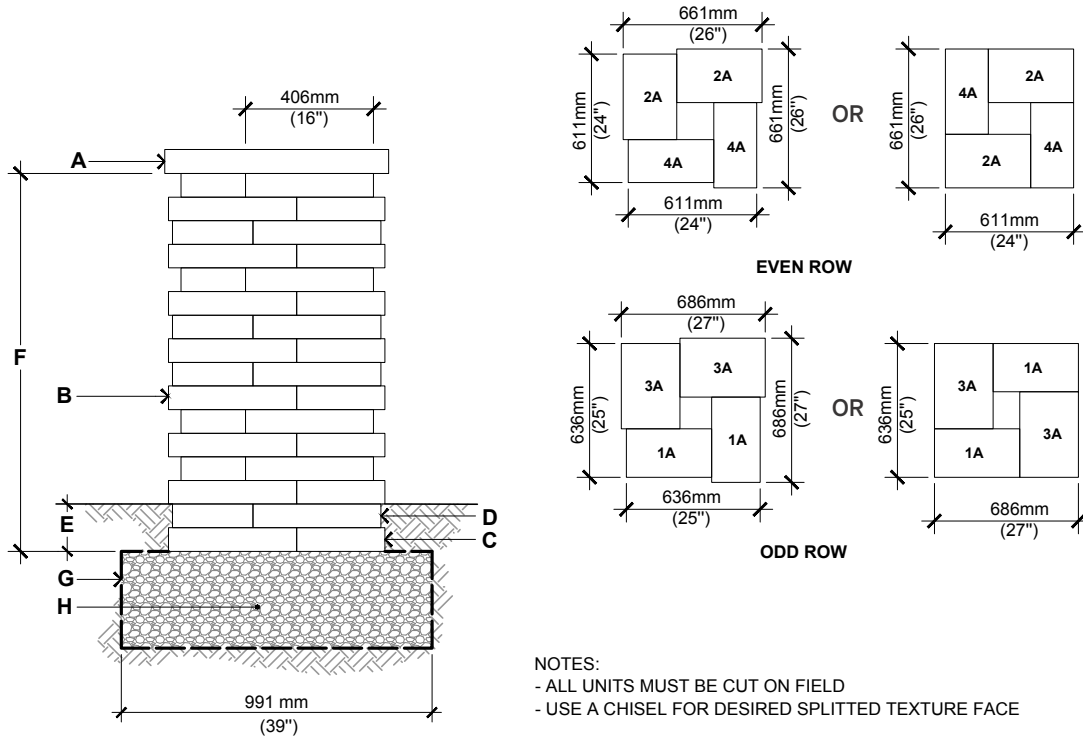

GRAPHIX

- A.** PILLAR CAP UNIT (SECURE WITH CONCRETE ADHESIVE)
- B.** GRAPHIX CORNER UNIT
SECURE EACH ROW WITH CONCRETE ADHESIVE
CUT EACH BLOCK AT 16" (406 mm) FROM THE CORNER EDGE
- C.** USE THE BLOCKS 1A-3A FOR THE ODD ROWS
- D.** USE THE BLOCKS 2A-4A FOR THE EVEN ROWS
- E.** EMBEDMENT DEPTH 6" (150 mm) MIN.
- F.** 23 5/8" (600 mm) HEIGHT PER PALLET
47 1/4" (1200 mm) MAXIMUM HEIGHT
- G.** GEOTEXTILE
- H.** COMPACTED GRANULAR BASE 6" (150 mm) THICK MIN.
THICKNESS ACCORDING TO PROJECT SPECIFIC CONDITIONS

For all possible combinations of pillars and caps, please refer to the correspondence table on page 103