



MANCHESTER FOYER SHALE GREY

DESCRIPTION: Fireplace **TEXTURE:** Smooth and Aged

Top Section (with chimney)	imperial	metric
Approx. Weight	2 134 lbs	968 kg
Height	53 1/4"	1 353 mm
Width	52"	1 321 mm
Depth	32"	813 mm

Woodbox (With York Cap)	imperial	metric
Approx. Weight	1 568 lbs	711 kg
Height	30 1/4"	768 mm
Width	33"	838 mm
Depth	34"	864 mm

Bottom Section	imperial	metric
Approx. Weight	4 985 lbs	2 261 kg
Height	43 1/2"	1 105 mm
Width	59"	1 499 mm
Depth	43"	1 092 mm



NOTES

See 256 for more technical information.



Report number: 0538WF001S

UL-127 & ULC-S610 compliant

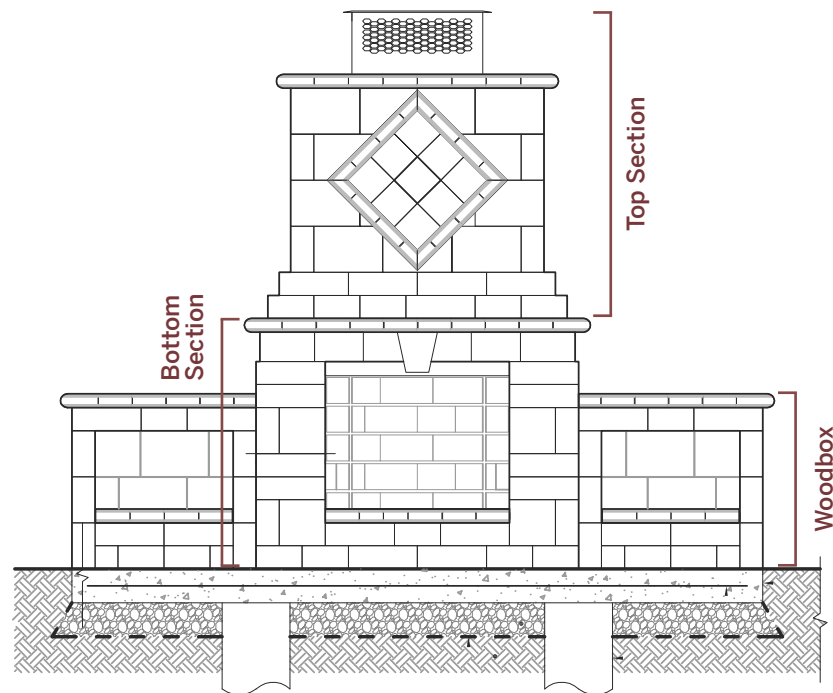

FRONT

shale grey



INSTALLATION GUIDE

MANCHESTER FOYER SHALE GREY

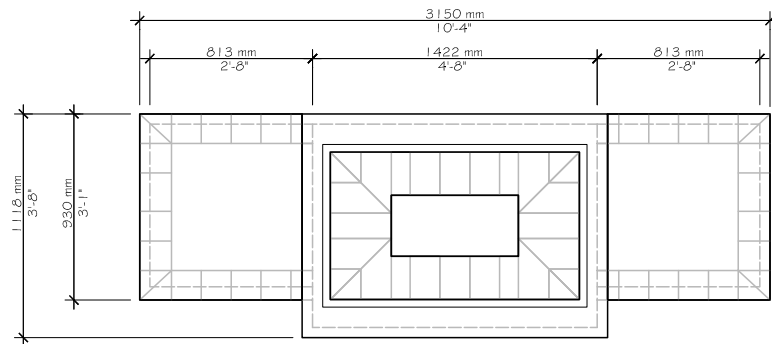

TOP

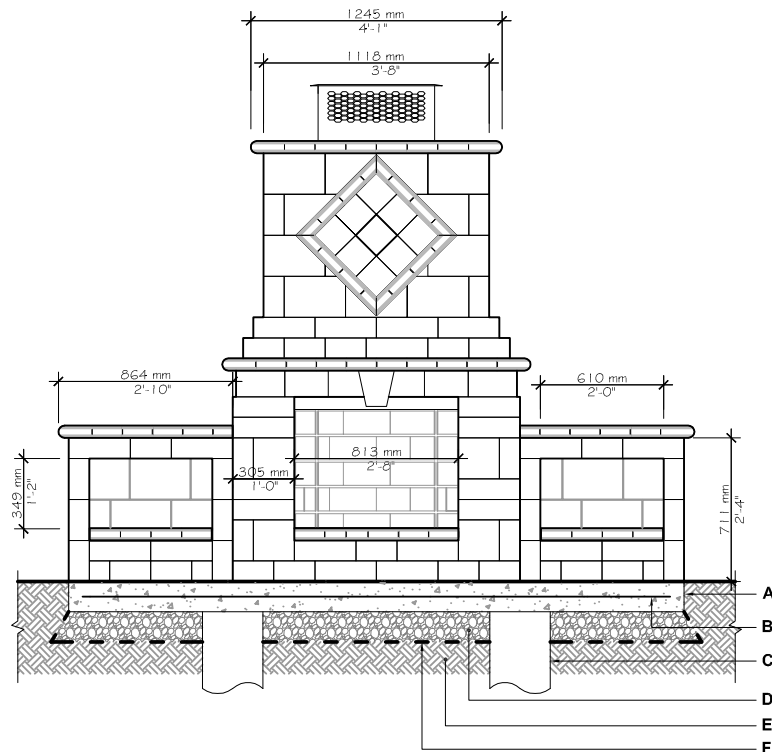

FRONT

- A. CAST IN PLACE CONCRETE SLAB - 30 MPa 150 mm (6") THICK
- B. 152 × 152 MW 18.7 × MW 18.7 (6 × 6-W2.9 × W2.9) WELDED WIRE MESH AS PER SITE CONDITIONS
- C. 300 mm (12") Ø CONCRETE PILLAR FOUNDATION EXTENDED TO 150 mm (6") BELOW FROST LINE AS PER SITE CONDITIONS AND LOCAL BUILDING REGULATIONS
- D. 20 mm (3/4") CLEAN STONE 150 mm (6") THICK MIN. AS PER SITE CONDITIONS
- E. NATURAL SOIL OR COMPACTED BACKFILL
- F. GEOTEXTILE

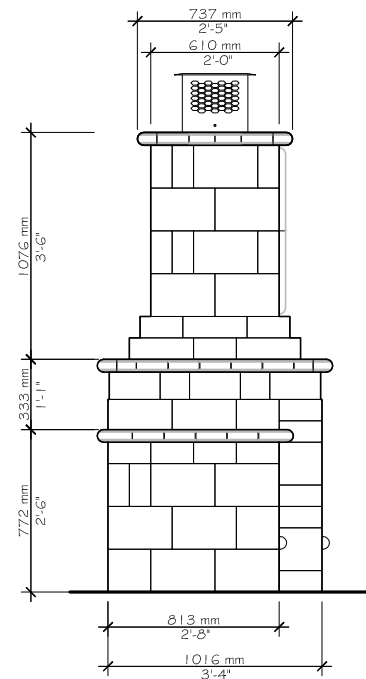

SIDE

Consult our Installation Guide in our website for a detail step by step installation.

The installer must ensure that the installation and use of the fireplace comply with local regulations and code requirements. Concrete pillars extending to frost line may be required as per local code. Check your local building code before installing.



MANCHESTER FOYER CHESTNUT BROWN

DESCRIPTION: Fireplace **TEXTURE:** Smooth and Aged

Top Section (with chimney)	imperial	metric
Approx. Weight	2 134 lbs	968 kg
Height	53 ³ / ₈ "	1 356 mm
Width	52"	1 321 mm
Depth	32"	813 mm

Woodbox (With Bullnose Cap)	imperial	metric
Approx. Weight	1 568 lbs	711 kg
Height	30 ³ / ₈ "	772 mm
Width	34"	864 mm
Depth	36 ⁵ / ₈ "	930 mm

Bottom Section	imperial	metric
Approx. Weight	4 985 lbs	2 261 kg
Height	43 ¹ / ₂ "	1 105 mm
Width	60 ¹ / ₈ "	1 527 mm
Depth	44"	1 118 mm



NOTES

See 258 for more technical information.



Report number: 0538WF001S

UL-127 & ULC-S610 compliant

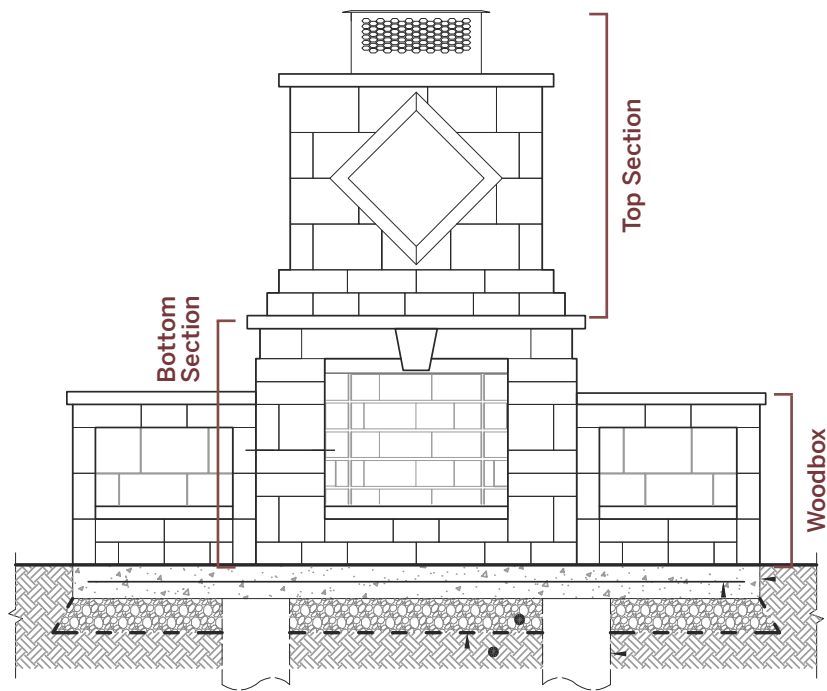

FRONT

chestnut brown

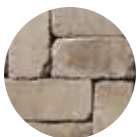

INSTALLATION GUIDE

MANCHESTER FOYER CHESTNUT BROWN

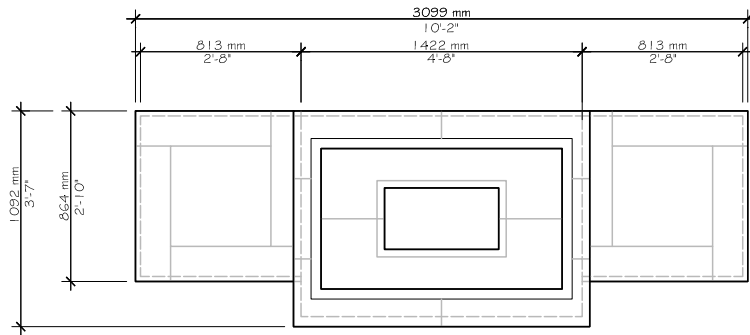

TOP

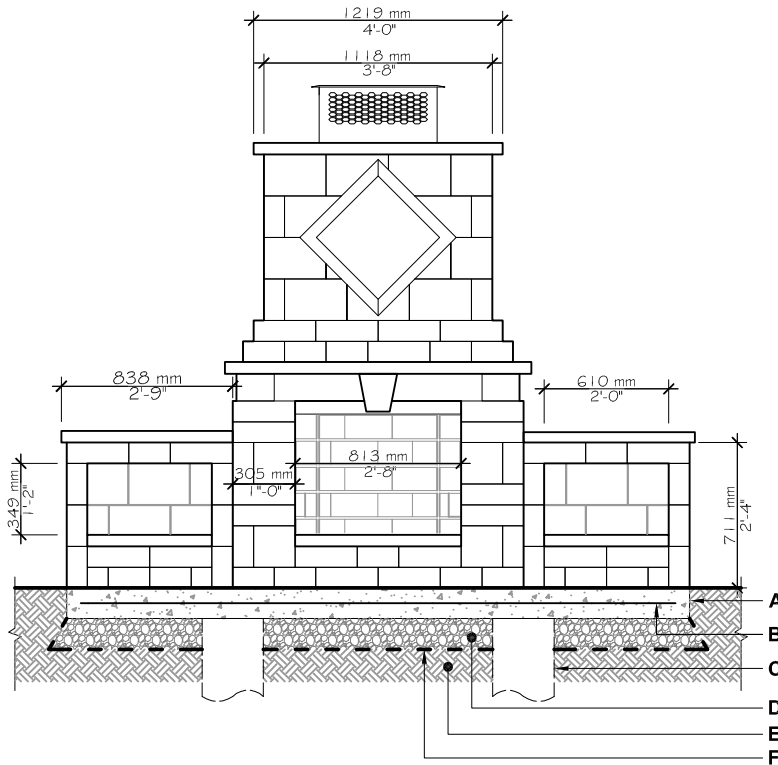

FRONT

- A. CAST IN PLACE CONCRETE SLAB - 30 MPa 150 mm (6") THICK
- B. 152 × 152 MW 18.7 × MW 18.7 (6 × 6-W2.9 × W2.9) WELDED WIRE MESH AS PER SITE CONDITIONS
- C. 300 mm (12") Ø CONCRETE PILLAR FOUNDATION EXTENDED TO 150 mm (6") BELOW FROST LINE AS PER SITE CONDITIONS AND LOCAL BUILDING REGULATIONS
- D. 20 mm (3/4") CLEAN STONE 150 mm (6") THICK MIN. AS PER SITE CONDITIONS
- E. NATURAL SOIL OR COMPACTED BACKFILL
- F. GEOTEXTILE

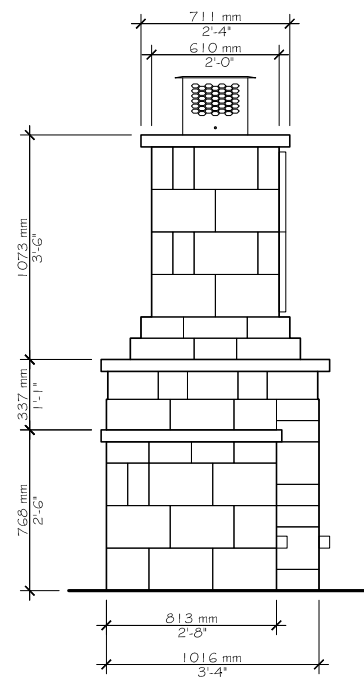

SIDE

OUTDOOR
FEATURES

Consult our Installation Guide in our website for a detail step by step installation.

The installer must ensure that the installation and use of the fireplace comply with local regulations and code requirements. Concrete pillars extending to frost line may be required as per local code. Check your local building code before installing.